

# NewLath 805 Mesh Membrane

## Damp Proofing Membrane & Plaster Base

Revision: 4.0 - 31<sup>st</sup> May 2022  
Codes: M9 & M10

### INTRODUCTION

*Newton NewLath 805 Mesh Membrane is an internally applied, composite damp proofing membrane, comprising of high-density polypropylene membrane with a rot-proof polythene mesh that is heat-welded during manufacturing to the surface of one side. The meshed surface creates a mechanical key to allow the membrane to be plastered, rendered or to receive dot & dab plasterboard.*

*Formerly Newlath 2000, NewLath 805 is one of a range of membranes within the [Newtonite System](#) of damp proofing products. If the meshed surface is not required because the wall finish will be a block wall or timber or metal frame, use [Newtonite 803](#) membrane instead.*

*NewLath 805 Mesh Membrane has a pattern of raised studs linked by reinforcing ribs. The 3mm or 5mm studs face the wall and create air channels that allow for vapour equalisation to take place between the membrane and the wall.*

*NewLath 805 is light, clean and easy to handle. It can be cut with a sharp knife, scissors or shears. The membrane is inert and is highly resistant to water, alkalis, saline solutions and organic acids, and it is not affected by minerals. It is also resistant to bacteria, fungi and other small organisms.*

*Newton NewLath 805 is guaranteed against deterioration for 30 years, and has a life expectancy of at least 50 years.*

### KEY BENEFITS

- Provides a surface that is totally separated and unaffected by the dampness within the wall, ensuring that the wall finish will never be affected by moisture or salts
- Superb 'key' for renders or plasters
- No need to use injected damp proof courses which unnecessarily pump chemicals into the property
- Completely moisture resistant but allows vapour diffusion
- Quick and easy to install
- In some cases, the existing render can be left on the wall
- No requirement for damaging preparation to the wall surface

### TYPICAL APPLICATIONS

- As a damp proof base for renders, plasters or dot & dab plasterboard
- As a damp proofing system to deal with rising damp

### SUITABLE SUBSTRATE - INTERNAL WALLS

- Concrete
- Brick
- Concrete block

### SPECIALIST TOOLS REQUIRED

- High quality SDS drill and drill bits
- A rotating laser level is recommended but not required

### TRAINING AND COMPETENCY OF THE USER

The diagnosis of damp and the specification of correct use of NewLath 805 will, in many cases, require the intervention of a specialist in the field of damp remediation.



### PRODUCT WARRANTY

Newton NewLath 805 is supplied with a product warranty of 30 years, and has a life expectancy of at least 50 years (DIN 9001:2000).

# NewLath 805 Mesh Membrane

## Damp Proofing Membrane & Plaster Base

### TECHNICAL DATA

Features	M9	M10	Units	
Material	HDPE	HDPP		
Colour	Translucent white			
Density	505	500	g/m <sup>2</sup>	
Width	1.2	2.0	m	
Length	10.0	20.0	m	
Area	12	40	m <sup>2</sup>	
Membrane thickness	0.6	1.50	mm	
Stud depth	3	2.90	mm	
Height	3	4.40	mm	
Vicat softening temperature	126	148	°C	
Packaged weight	?	19.00	kg	
Service temperature	-50 to +80	-40 to +80	°C	
Installed Performance	M9	M10	Units	Test Method
Thermal conductivity	-	0.480	W/mK	EN 12667
Water vapour resistance – Sd value	-	200	m	BS EN 1931
Water vapour resistance – μ value	-	400000	μ	Calculated from SD value
Water vapour diffusion resistance	-	1000	MNs/g	Calculated from SD value
Resistance to fire	Euroclass F	Euroclass E		BS EN 13501-1
Chemical resistance – Excellent	-	100	%	EN14030
Oxidation resistance – Excellent	-	100	%	EN ISO 13438
Water tightness @ 60 kPa; 24h	Pass	Pass	-	EN 1928
Tensile strength MD	416	-	N	BS 12311-2
Tensile strength CD	488	-	N	BS 12311-2
Resistance to static loading	>20	>20	kg	BS 12730
Compressive strength	250	-	kN	BS EN ISO 25619-2

### LIFE EXPECTANCY

When specified, installed and protected in accordance with this Data Sheet and Installation Manual, and fully and permanently isolated from UV light and physical damage or wearing, and only to those substrates confirmed within, NewLath 805 has a service life that can be equal to the design life of the structure.

### SPECIFICATION

Newton Waterproofing Systems work in partnership with RIBA NBS who publish our products on [NBS Source](#). The platform integrates seamlessly into project workflows, providing all product data from Newton's NBS BIM Objects, NBS Plus Clauses and RIBA Product Selector into one single source of product information.

NBS Source also hosts a large selection of Newton [case studies](#), as well as product [literature and certifications](#).

A wide range of drawings are available [on our website](#)

### COLOUR

Translucent white.

### PROTECTION OF THE MEMBRANE

The membrane should always be protected by suitable surface finishes.

Protection methods include:

- Plaster
- Render
- Dot and dabbed plasterboard
- Dot and dabbed ply

**NOTE:** Newton NewLath 805 is fire rated to Euroclass E, the same as plastic-based insulation. As such the membrane must always be protected from fire by surface finishes, as would be the case with insulation.

# NewLath 805 Mesh Membrane

## Damp Proofing Membrane & Plaster Base

### TYPICAL DETAIL

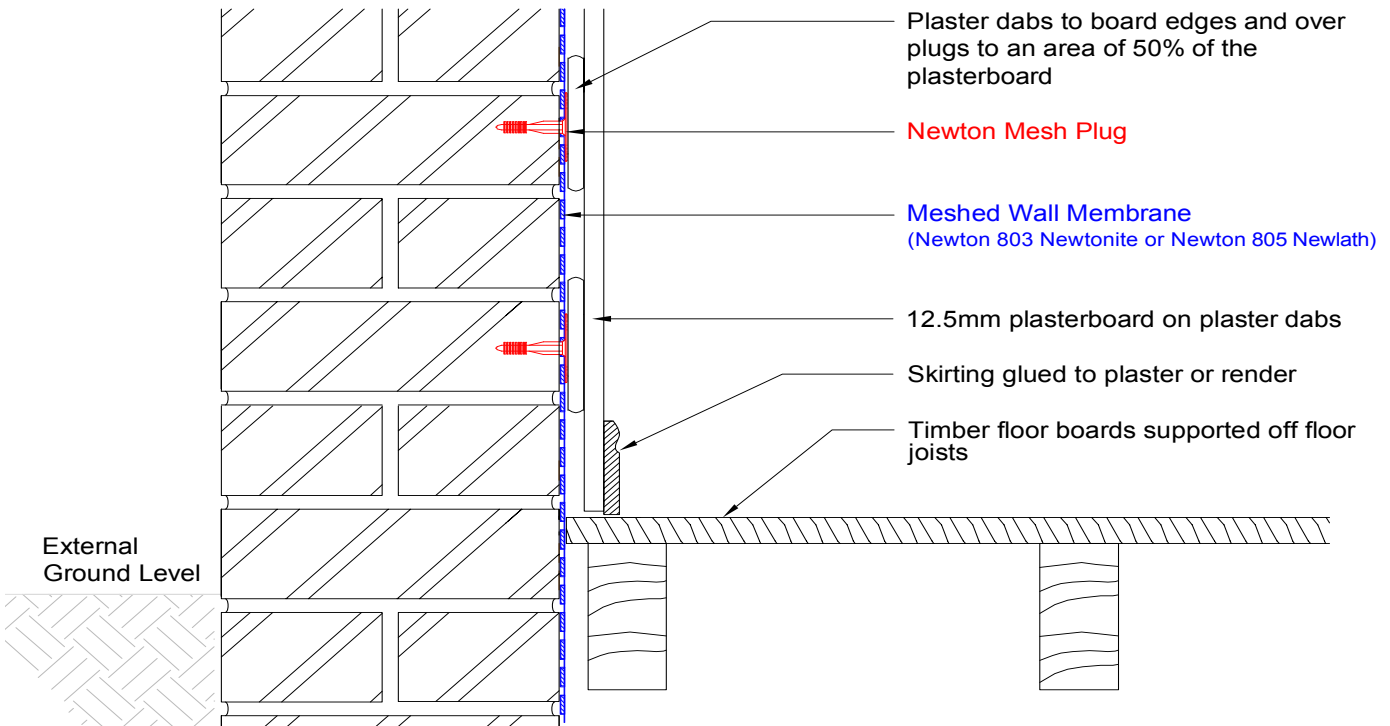

### SURFACE PREPARATION

- Clean the substrate to remove all loose debris and organic matter. Plaster should be removed as it can soften over time, which will weaken the fix of the membrane to the wall. If the wall render is in good condition, it does not have to be removed and the NewLath 805 can be fitted directly over. If the render is damaged, local repairs may be required
- Loose or crumbling render should be removed and local repairs made. If the render is in very poor condition, all of it may need to be removed
- Obtain as flat a surface as possible. If the wall is undulating, better results are produced if the wall surface is dubbed-out flat with sand & cement prior to installation of the membrane rather than dubbing out over the top of the NewLath 805. A flat, uniform surface to the substrate means that the plaster or render above the NewLath 805 will be uniform also and less likely to have cracking caused by differential thicknesses
- If evidence of bacterial growth can be seen, use a fungicidal product prior to the fitting of the membrane
- If any evidence of wet rot or dry rot is seen, have it dealt with by a qualified remedial specialist
- If a new slab is to be laid as part of the works, it is preferable to fit NewLath 805 prior to the laying of the floor slab with the floor DPM extending upwards in front of the NewLath 805, ready for the concrete placement

### CUTTING TO SIZE

- NewLath 805 can be cut with a sharp utility knife, scissors or shears
- Decide whether the membrane is to be fitted horizontally or vertically

### MEMBRANE JOINTING

- Joints may be made horizontally or vertically
- Joints are created by butt jointing the two edges together and then sealing over the joints with [Newton Mesh Tape](#)
- NewLath 805 can be taken around corners. On particularly difficult shaped corners, cut the NewLath 805 and butt joint and seal as above
- Newton Mesh Tape should be firmly pressed into the mesh of the NewLath 805 to facilitate the joint. In cold and damp conditions a heat gun should be used to gently evaporate surface moisture and then to assist in pressing the Mesh Tape into the mesh of the membrane

### SEALING AROUND PROTRUSIONS

Where the membrane has to be cut around pipes or other protrusions, carefully cut the membrane around the protrusion and then seal around the protrusion with [Newtonite 801 Mastic](#) to ensure there is no bridging between the damp substrate and the new finish.

# NewLath 805 Mesh Membrane

## Damp Proofing Membrane & Plaster Base

### FIXING TO THE WALL

- Cut the membrane to size. Ideally, NewLath 805 should be continued up into ceiling voids and down past the slab to the oversite. If this is not possible, cut the membrane so that it finishes tightly to the soffit and floor finish. A gap is not required at the soffit or floor, indeed the system works more efficiently when the system is not ventilated as this impedes the natural vapour drive from inside the property to the outside that still continues through the Newton NewLath 805
- NewLath 805 is fitted to the wall with the studs facing the wall and the flat meshed surface facing inwards towards the applicator. Fix the membrane to the wall with the [Newtonite Mesh Plug](#) to all substrates except when fixing to plywood or timber, when a galvanised clout nail should be used, or to slightly friable mortar substrate, when the [Newtonite Cob Plug](#) should be used
- NewLath 805 can be fitted horizontally or vertically
- Fit the membrane as level as possible - best results are achieved when a long builders level or a rotating laser level is used. Care must be taken to ensure that the NewLath 805 is pulled tight and square while fixing as this will avoid sagging or bulging which can cause problems when plastering or rendering
- Using a 7mm or 8mm drill bit (depending on substrate), drill through the membrane into the wall to a depth of at least 50mm (or 60mm if you are using the A16 Newtonite Mesh Plug)
- Apply a bead of Newtonite 801 Mastic around the hole so that when the plug is hammered home, the Mastic will seal between the plug and the membrane and so prevent migration of dampness and salting from the substrate to the wall finish
- Use a small number of fixings to initially fit the membrane to the wall as level as possible
- Once the section of membrane is on the wall add the further fixings
- Hammer the plugs home using a wide headed hammer such as a lump hammer or mallet
- A smaller-diameter bit can be used on softer substrate to ensure a tight fit for the plug
- Fixing centres internally must not be greater than 250mm
- On curved or uneven surfaces, closer fixings should be used
- On exposed areas closer fixings are recommended, to restrain possible thermal movement
- Fit the membrane by 300mm to return walls to isolate wall finishes from dampness transmitting from the main wall being treated
- NewLath 805 can be taken into reveals
- Do not install above 30°C or below -5°C

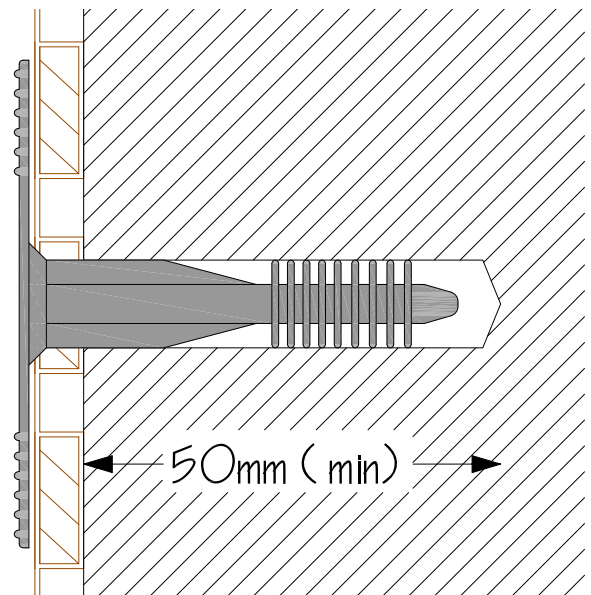

### FINISH (GENERAL)

- NewLath 805 is suitable for wall finishes including plaster, render, hydraulic lime or plasterboard bonded to the membrane with a propriety adhesive compound
- Whilst cement-based renders are prone to cracking, careful application can reduce or avoid this. Problems occur when the scratch coat has not been allowed to fully cure prior to the float coat being applied, but the most common problem we see is where the render has not been allowed to fully cure due to accelerated drying. It is extremely important that the render is slowly cured for a period of 7-10 days, longer if possible. The render gets its strength from the chemical processes that take place between the cement content and the added water. The cement needs the correct amount of water to be available to it during the whole of the curing period. If the render dries too quickly due to exposure to sunlight, wind or even dehumidification, the cement will not be able to react with water, producing a weak render that will be prone to cracking
- The render should be dampened regularly during the curing process and protected from accelerated drying with hessian and plastic sheeting
- Hairline cracking can be made good with fine fillers or alternatively a high-build masonry paint can be applied

**DO NOT APPLY DECORATIONS UNTIL PLASTERS OR RENDERS ARE THOROUGHLY DRY.**

### PUNCTURING THE MEMBRANE

If the finished wall is punctured when holes are drilled to fix brackets, etc., Newtonite 801 Mastic should be inserted before fixing bolts are inserted to ensure no bridging from the damp substrate occurs.



# NewLath 805 Mesh Membrane

## Damp Proofing Membrane & Plaster Base

### COVERAGE

M9: 12m<sup>2</sup>.

M10: 40m<sup>2</sup>.

### PLASTERING

- The recommended plaster for NewLath 805 is [Tarmac Limelite Whitewall One Coat](#). Please note that we do not recommend that this product is used in one single coat to Newton meshed membranes
- The application of the plaster should be in two coats: 6mm scratch coat, 6mm second or float coat
- If a finish coat is required this should be of 3mm
- Limelite Whitewall One Coat should be applied in accordance with good plastering practice as described in BS 8481:2006, BS EN 13914-2:2005
- Always allow 24 hours drying time between coats of plaster. For a high impact resistant finish, use Limelite Whitewall High Impact Backing Plaster
- NOTE: Limelite Whitewall One Coat is not suitable for areas of high humidity and wet areas such as swimming pool surrounds

### PLASTERBOARD ON DABS

Plaster board panels can be fixed to NewLath 805 by the dot and dab method, giving a dry surface ready for immediate decoration.

'Dabs' should be applied to the heads of the Newtonite Mesh Plugs, board edges and membrane to cover 50% of the NewLath 805.

NOTE: We do not recommend that laminated or insulated plasterboard is dot & dabbed to Newton meshed membranes.

Laminated boards have to be fixed to the wall with a mechanical fixing at each side of the board, just above half way up, so that the board does not come apart and block exits during a fire. This is a requirement of UK building code. It is not possible to mechanically fix through the laminated board without puncturing the membrane. If insulation is required to the wall build, use Newtonite 803, which is not meshed, with an independently supported wall frame.

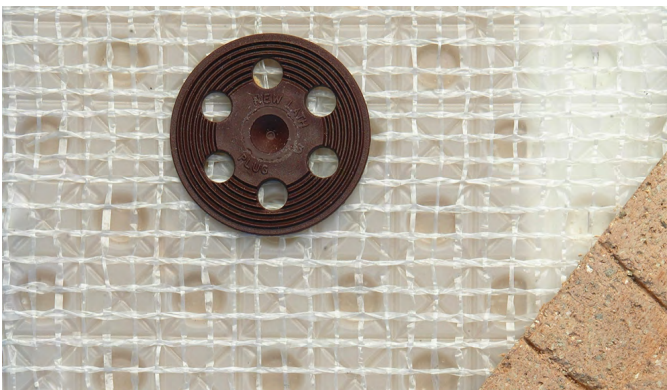

### RENDERING

- Render with a mix of sand, cement and lime should be applied in two coats using the procedures defined within BS EN 13914-1:2005 to a total thickness of 14mm
- A 3mm skim coat of finishing plaster can be added once the render is fully cured
- The scratch coat should be a mix of 1 part lime: 1 part cement: and 5 parts clean well-graded sharp sand. The second or float coat should be a mix of 1 part lime: 1 part cement: and 6 parts clean well-graded sharp sand. The scratch coat should be 7mm and the second or float coat should be 7mm
- To lessen incidents of cracking, it is best to mix the lime and sand a day or more before use. Cement can then be added at the time of rendering
- The work should be of two coats of render and if required, a third coat of finishing plaster. The purpose of the 7mm scratch coat is to stiffen up the lath and to provide rough and absorbent, backing for subsequent coats
- Work this scratch coat well into the mesh
- Each 7mm coat of render should be allowed to dry for a period of not less than seven, preferably ten days, longer if possible. Cracking may occur if shorter time is allowed between coats
- It is important that the render coats are allowed to cure correctly over the 7 to 10 day period with the render dampened as required. If the scratch coat has not fully cured, slumping of the render can result
- Before applying the second or float coat, carefully drill or scratch out a small section into an area behind the mesh, within the membrane stud, to confirm that it is fully cured. The surface will cure quite quickly but the area behind the mesh must be fully cured also
- In warm periods the render should be protected from excessive drying out by covering with damp hessian sheets and plastic sheeting over it
- Dampen down the scratch coat before application of the float coat
- A smooth finish is not recommended
- Expansion joints should be trowelled in through the render to the membrane. These joints must be filled with a suitable flexible polymer-based sealant
- Expanded metal angle beads and stop beads can be fixed where appropriate using dabs of the same material mixed as for the scratch coat

# NewLath 805 Mesh Membrane

## Damp Proofing Membrane & Plaster Base

### HYDRAULIC LIME

- NHL (Natural Hydraulic Lime) 3.5 should be used to a combined depth of 20mm with a 10mm scratch coat and a 10mm second or float coat
- The mix ratio is 2.5 parts sand to 1 part NHL 3.5 mixed as per manufacturers instructions
- The 10mm scratch coat is pushed firmly into the membrane mesh
- Check the application the day after and rub out any cracks
- The surface should be thoroughly scratched without breaking the surface of the mesh
- The scratch coat has to be left for a minimum of 7 days to set. It should be protected from draughts and extremes of temperature
- Before applying the second or float coat, carefully drill or scratch out a small section into an area behind the mesh, within the membrane stud, to confirm that it is set and reasonably hard. The surface will cure quite quickly but the area behind the mesh that has to be set
- The second coat is the float coat and is applied then ruled off to flatten the wall surface. The mix ratio is 2.5 parts sand to 1 part NHL 3.5 mixed as per manufacturers instructions
- The scratch coat has to be dampened down before application of the float coat
- The work has to be protected and tended as per the scratch coat. The second coat is floated or trowelled so a finish coat or a further coat can be applied

### FIXING OBJECTS TO THE WALL

Objects should be attached to the wall using resin anchors. Seal around the resin anchor with Newtonite 801 Mastic.

### LIMITATIONS

- NewLath 805 is a damp proofing product for use to above ground (non earth-retaining) structures only. If the wall(s) to be treated have earth to the other side this product is not suitable and our [CDM System](#) waterproofing products should be used instead
- Not UV stable
- Fixing to full height to multiple elevations will inhibit vapour drive that naturally moves humidity out of the building. Humidity control systems should be used to control humidity
- Whilst NewLath 805 can be used to deal with penetrating dampness, this should only be considered after building defects such as defective pointing, cracking and defective rainwater goods have been repaired or made good and [Diasen BKK](#) has been applied to the substrate to prevent the wall taking in rain water

### STORAGE

NewLath 805 should be stored with the rolls standing up on end and away from direct sunlight.

### PACKAGING

1.2m x 10m - Product code M9.

2.0m x 20m - Product code M10.

### HEALTH & SAFETY



Product should only be used as directed. Although the NewLath 805 poses no health hazards, usual protective clothing and goggles should be worn in accordance with current health and safety regulations.



We always recommend that the Safety Data Sheet (MSDS) is carefully read prior to application of the material. Our recommendations for protective equipment should be strictly adhered to for your personal protection. The SDS is available upon request from Newton Waterproofing Systems or online via our website. Please see contact details below.

Newton Waterproofing Systems reserve the right to update product literature at any time. Please always refer to our [website](#) for the latest versions.

# NewLath 805 Mesh Membrane

Damp Proofing Membrane & Plaster Base

		Newton Waterproofing Systems Newton House 17-20 Sovereign Way Tonbridge Kent TN9 1RH	M9 BS EN 13967:2012 Waterproofing sheet for damp proof sheets, type V.	
			<b>Essential characteristics to EN 13967: 2012 + A1 : 2017</b>	<b>Test Standard &amp; Conditions</b>
Water tightness, 60 kPa; 24h		EN 1928	Pass	
Resistance to tearing		EN 12310-1	MD - NPD CMD - NPD	
Elongation (5%)		EN 12311-2	MD - NPD CMD - NPD	
Compressive creep (resistance to static load)		EN 13967 Annex B	NPD	
Impact resistance		EN12691-2 Method A	NPD	
Durability against ageing		EN 1296 / EN 1928	NPD	
Durability against chemicals		EN 1926 / EN 1928	NPD	
Fire resistance		EN 13501-1:2007+A1:2009	E	
Joint tensile shear resistance		EN 12317-2		
Compressive strength		BS EN ISO 25619-2	250	kN

		Newton Waterproofing Systems Newton House 17-20 Sovereign Way Tonbridge Kent TN9 1RH	M10 BS EN 13967:2012 Flexible Natural Translucent And Dimpled Waterproofing Sheet With White Mesh For Plasters And Renders.	
			<b>Essential characteristics to BS EN 13967:2012 Type V, ZA.1 and ZA.2 class +2</b>	<b>Test Standard &amp; Conditions</b>
Reaction to fire		EN 13501-5	Class F	
Water tightness			Pass	
Tear resistance			> 300	N
Joint strength			NPD	
Impact resistance			>400	mm
Tensile strength			>350 / 50	N / mm
Resistance to static load			>200	N
Water tightness after artificial ageing			Pass	
Water tightness after exposure against chemicals			Pass	
Dangerous substances		REACH SVHC List	None	